

# FJD ISOBUS

Certified by AEF, FJD's guide and autosteering systems are compatible with ISOBUS, allowing you to get the most out of your machinery and make better decisions to enhance productivity.



ISOBUS Wiring Harness



ISOBUS Ready

# FJD ISOBUS

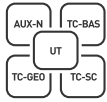

All-Round Features

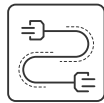

Extensive Compatibility

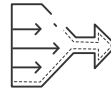

Simplified Workflow



Plug and Play



Precise Operation



Seamless Transfer



Smooth Interconnection



Yield Optimization

## UNIVERSAL TERMINAL (UT)

The universal terminal provides a unified platform for displaying and controlling implement systems, achieving efficient management of all compatible ISOBUS implements in just one terminal.



## AUXILIARY CONTROL "NEW" (AUX-N)

For implements and functions certified by the AUX-N standard, AUX-N facilitates your operation of complex equipment with additional control elements, such as a joystick and SwitchBox.





# TASK CONTROLLER BASIC (TC-BAS)

It records the total values of the implement operation like the total working area, and allows for seamless import of jobs to the task controller and export of completed records.

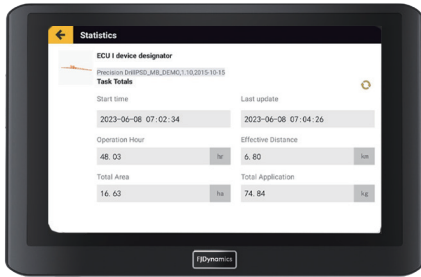

# TASK CONTROLLER SECTION CONTROL (TC-SC)

Implement sections are turned on and off automatically based on GPS location and desired overlap at field boundaries or when passing worked areas, ensuring that each section only engages when necessary.



# TASK CONTROLLER GEO-BASED (TC-GEO)

Site-specific location information gathered through GNSS technology can help manage the complexities of variable rate control (VRC), ensuring that the right amount of fertilizer and pesticides are applied in the right place of the field.

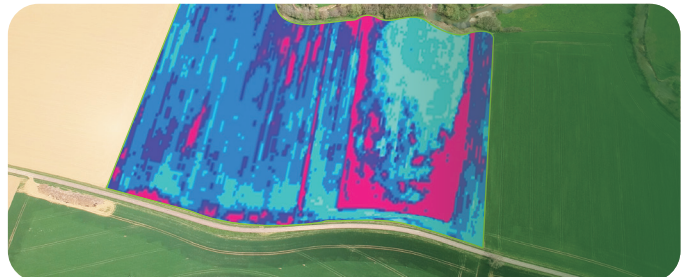

# SMART MULTI-CHANNEL SECTION CONTROL

The ISOBUS system supports precise multi-channel section and rate control. Moreover, it intelligently distinguishes infield from headland zones for accurate geo-based section control, helping you achieve more accurate input application and reduce waste.

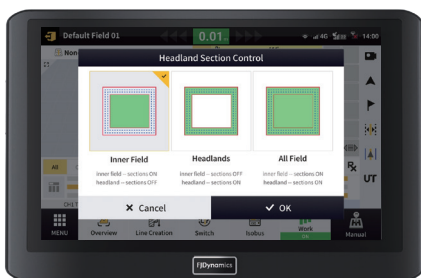

# FLEXIBLE SOLUTIONS FOR DIVERSE FARMING NEEDS

Two ISOBUS Extension Cable options are offered: 9-pin (6m/9m) and 4-pin (3m), so you can better work with various farming setups, including larger tractors and front-mounted implements.



You can also use an optional ISOBUS screen if you need a full screen for your implements or work with other brands of farm systems. This gives you a smooth and efficient control experience no matter how you're farming.



## APPLICATION SCENARIOS

### LIVE IMPLEMENT STATUS MONITORING

The ISOBUS system enables real-time status monitoring of key implements such as seeders, fertilizer spreaders, sprayers, and balers. This live view helps you check device performance, fix problems quickly, and make sure your ongoing tasks run smoother and more efficiently.



### PRECISION APPLICATION WITH VARIABLE RATE CONTROL

With variable rate control for implements like fertilizer spreaders and sprayers, the system can change application amounts based on how your crops are growing. You use only what's needed to reduce waste, helping your crops grow healthier and more evenly across the whole field.









### MULTI-CHANNEL JOINT OPERATION



The ISOBUS system lets you control sections and rates for each channel of implements separately in joint farming operations, such as seeding and fertilization at the same time. You can manage input management precisely with finer control, maximizing efficiency in every pass.





	Non-ISOBUS Ready Tractor		
	 ISOBUS Wiring Harness	 ISOBUS Universal Easy	 ISOBUS Universal Pro
Model	(Standard) ISOBUS Harness	ISOUNI-ESY	ISOUNI-Pro
AT2	✓ (AT2 V7 Version)	✓ (AT2 V8 Version)	
AT2 Max		✓	
AT2 Lite			✓
AH2		✓	
AS2		✓	
AG1			✓
AT1	✓		
AH1	✓		

	ISOBUS Ready Tractor		
	 ISOBUS Ready	 ISOBUS in-cab Cable	 ISOBUS Ready Pro
Model	ISORDY	In-cab	ISORDY-Pro
AT2	✓ (AT2 V7 Version)	✓ (AT2 V8 Version)	
AT2 Max		✓	
AT2 Lite			✓
AH2		✓	
AS2		✓	
AG1			✓
AT1	✓		
AH1	✓		

	For third-party Joystick	
	 In-cab Y-split Cable	 Joystick Extension Cable
Model	In-cab Y-split Cable	Joystick Extension Cable
AT2	✓ (Used for ISOBUS Ready Tractor)	✓ (Used for Non-ISOBUS Ready Tractor)
AT2 Max	✓ (Used for ISOBUS Ready Tractor)	✓ (Used for Non-ISOBUS Ready Tractor)
AT2 Lite	✓ (included in ISORDY-Pro)	✓ (Used for Non-ISOBUS Ready Tractor)
AH2	✓ (Used for ISOBUS Ready Tractor)	✓ (Used for Non-ISOBUS Ready Tractor)
AS2	✓ (Used for ISOBUS Ready Tractor)	✓ (Used for Non-ISOBUS Ready Tractor)
AG1	✓ (included in ISORDY-Pro)	✓ (Used for Non-ISOBUS Ready Tractor)
AT1	✓ (Used for ISOBUS Ready Tractor)	✓ (Used for Non-ISOBUS Ready Tractor)
AH1	✓ (Used for ISOBUS Ready Tractor)	✓ (Used for Non-ISOBUS Ready Tractor)

# ISOBUS WIRING HARNESS

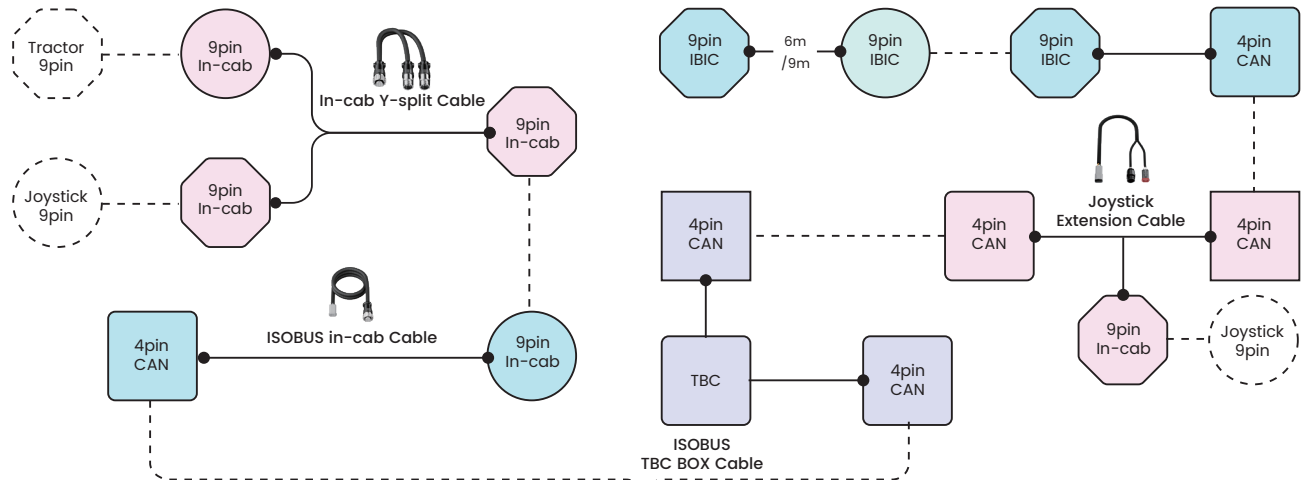

# ISOBUS TERMINAL

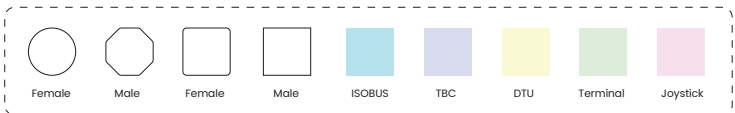
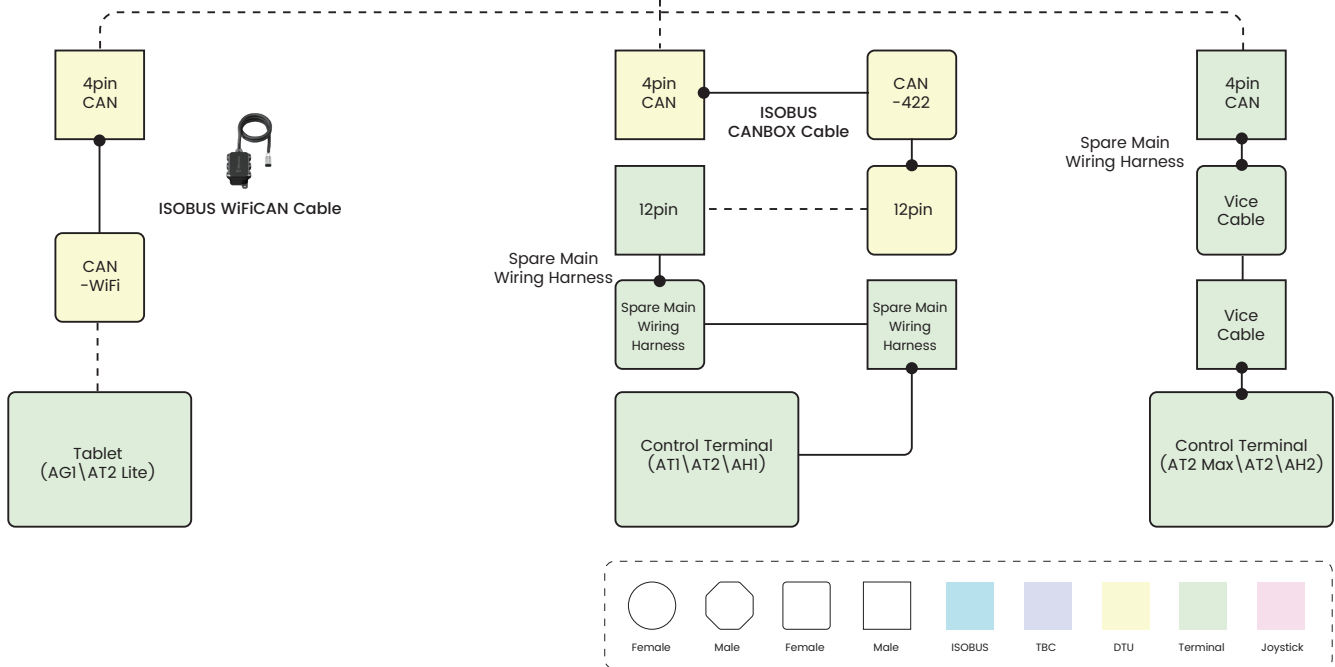

# QUICK SPECS

Max Input Current	50A
Communication Type	CAN
Transfer Protocol	ISO 11783
Operating Temperature	-30°C to 70°C
Operating Humidity	5%–95%
Storage Temperature	-45°C to 85°C
IP Rating	IP66
Data Transfer Rate	250 Kbps

Free Quote: [sales.global@fjdynamics.com](mailto:sales.global@fjdynamics.com)  
 Address: 15 SCOTTS ROAD #03-12, Singapore

[FJDynamics.com](http://FJDynamics.com)



CREATE FOR A BETTER WORLD

Copyright © FJDynamics. All rights reserved.