

## ■ Packing List

The Autosteering Kit for Agri-Vehicles

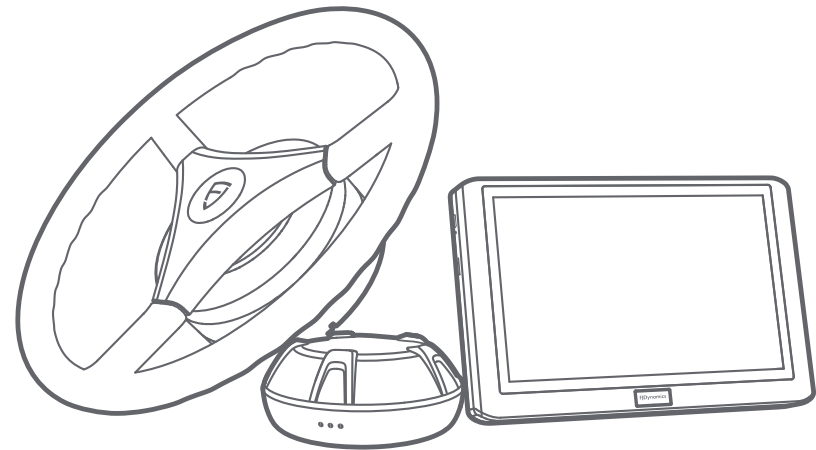

## FJDynamics AT2 Auto Steer System

---

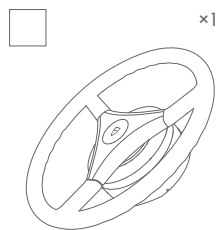

x1

Electric Steering Wheel

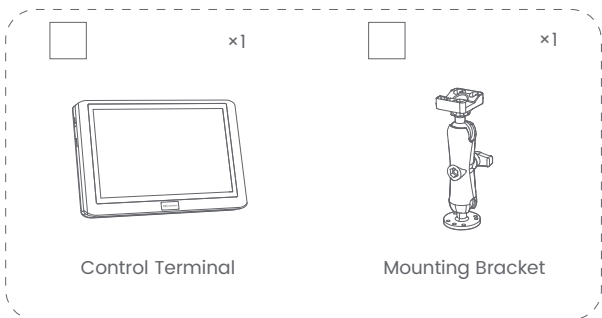

x1

Control Terminal

x1

Mounting Bracket



x6

Hexagon Socket Head Cap Screws M4x14



x6

Spring Washer M4



x6

Plain Washer M4

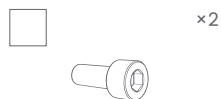

x2

Hexagon Socket Head Cap Screws M6x16



x2

Spring Washer M6



x2

Plain Washer M6

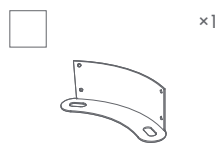

x1

Nameplate

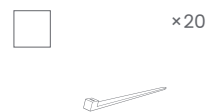

x20

(Nylon) Cable Ties



x1

Hardware Installation Manual



x1

Certification



x1

Warranty Card



x1

Software User Manual

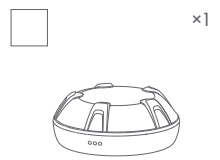

x1

GNSS Receiver

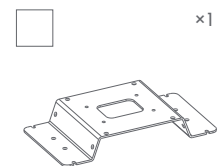

x1

Antenna Bracket

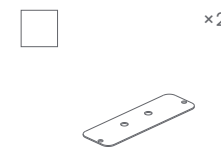

x2

3M Sticker



x4

Self Drilling Screw



x4

Assembly Bolt M4x12

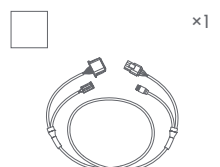

x1

Spare Main Wiring Harness

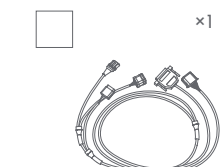

x1

Main Wiring Harness

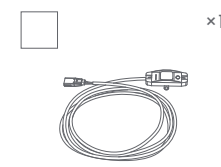

x1

Power Wiring Harness

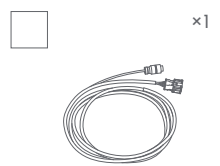

x1

GNSS Receiver Wiring Harness

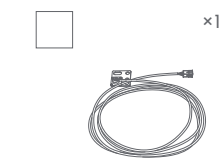

x1

Attitude Sensor Wiring Harness

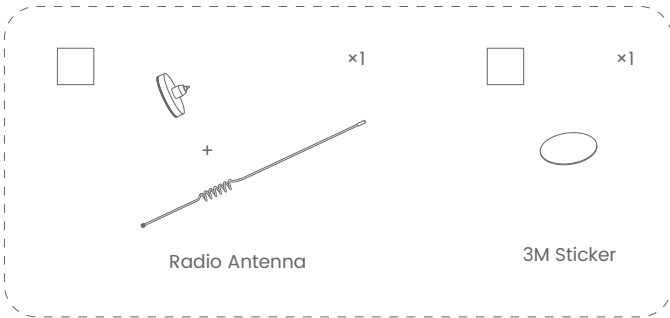

x1

Radio Antenna

x1

3M Sticker

Check that all the items above are in your package. If any items is missing, please contact FJ Dynamics or local dealer.

图纸区:

尺寸:210\*297mmm

材质:120g道林纸

颜色:Pantone cool gray

10C

工艺:/

技术要求:

- 1、开制刀模,模切公差±0.5mm;印刷内容以印刷稿为准,套印公差±0.5mm;
- 2、成品无破损、脏污,切口需平整;版面不允许明显凸起、偏移、重影、残缺、错版等不良;图案文字清晰、整洁,无脏污;
- 3、同一批次成品颜色无差异,不同批次无明显差异;

裁切线: 

压痕线: 

齿刀线: 

刷胶区: 

比例: 1:1

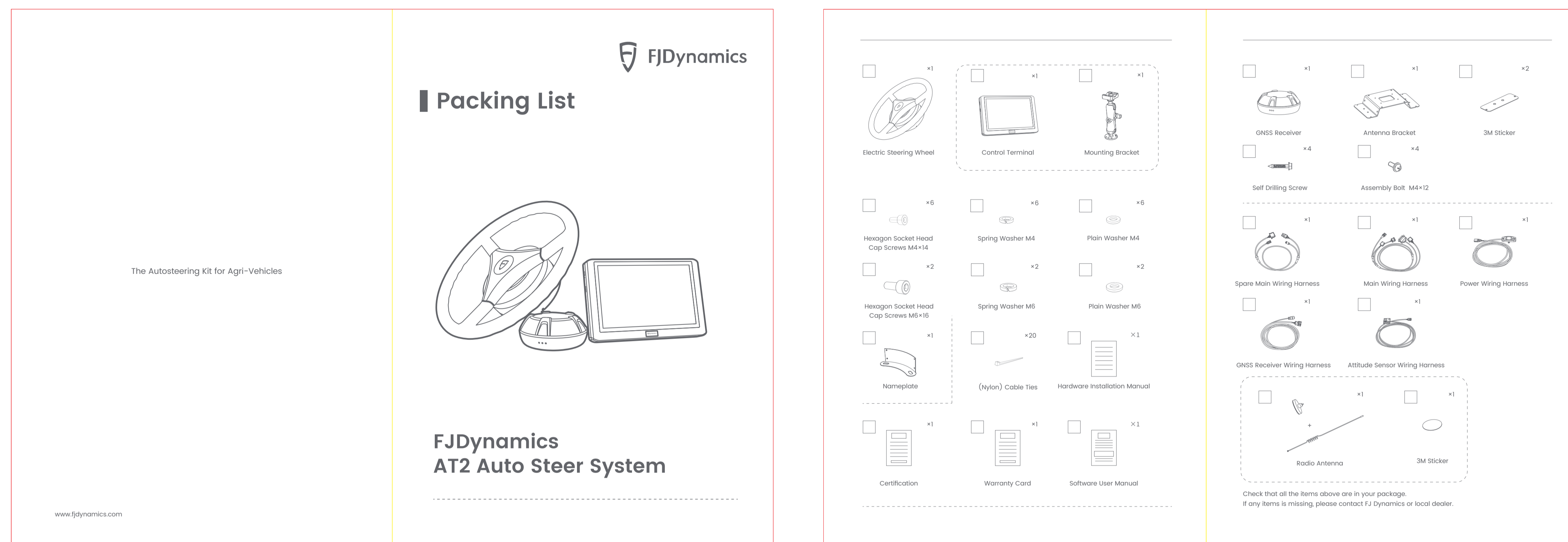

料号/图号		型号		名称	AT2装箱清单(欧美)	日期	2022/10/17
结构设计	Cassie.He	审核		版面设计	Cassie.He	审核	